

Kombiinstrument

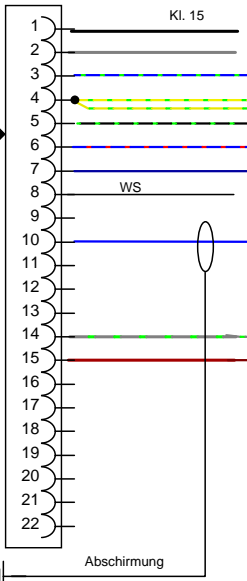

Choppertank

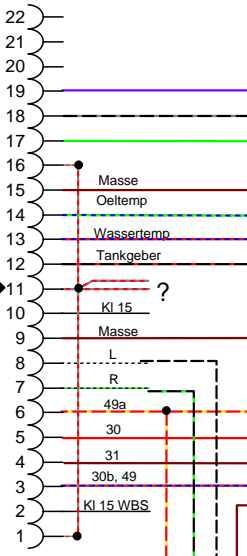

Kombisch.

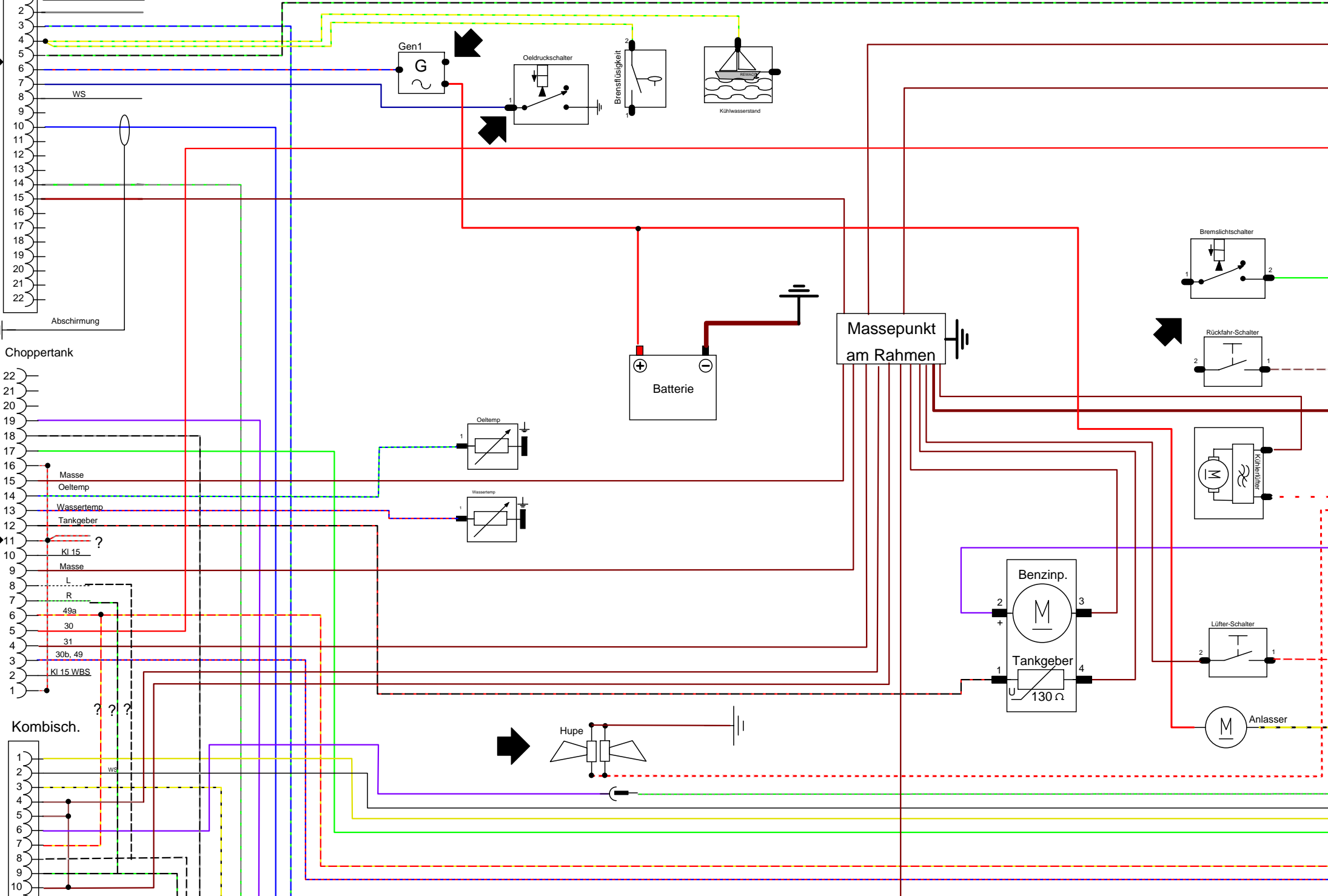
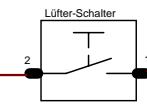
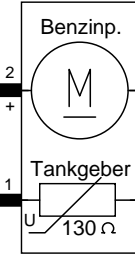
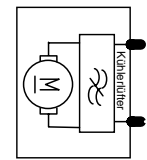
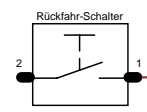
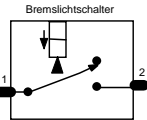
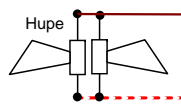
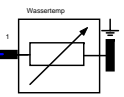
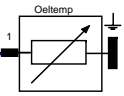
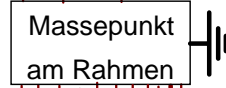
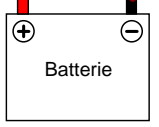
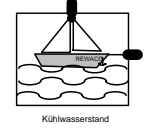
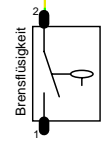
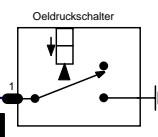
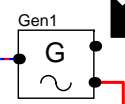
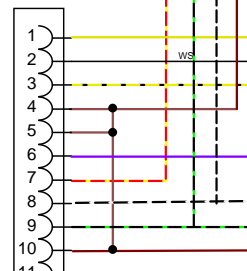

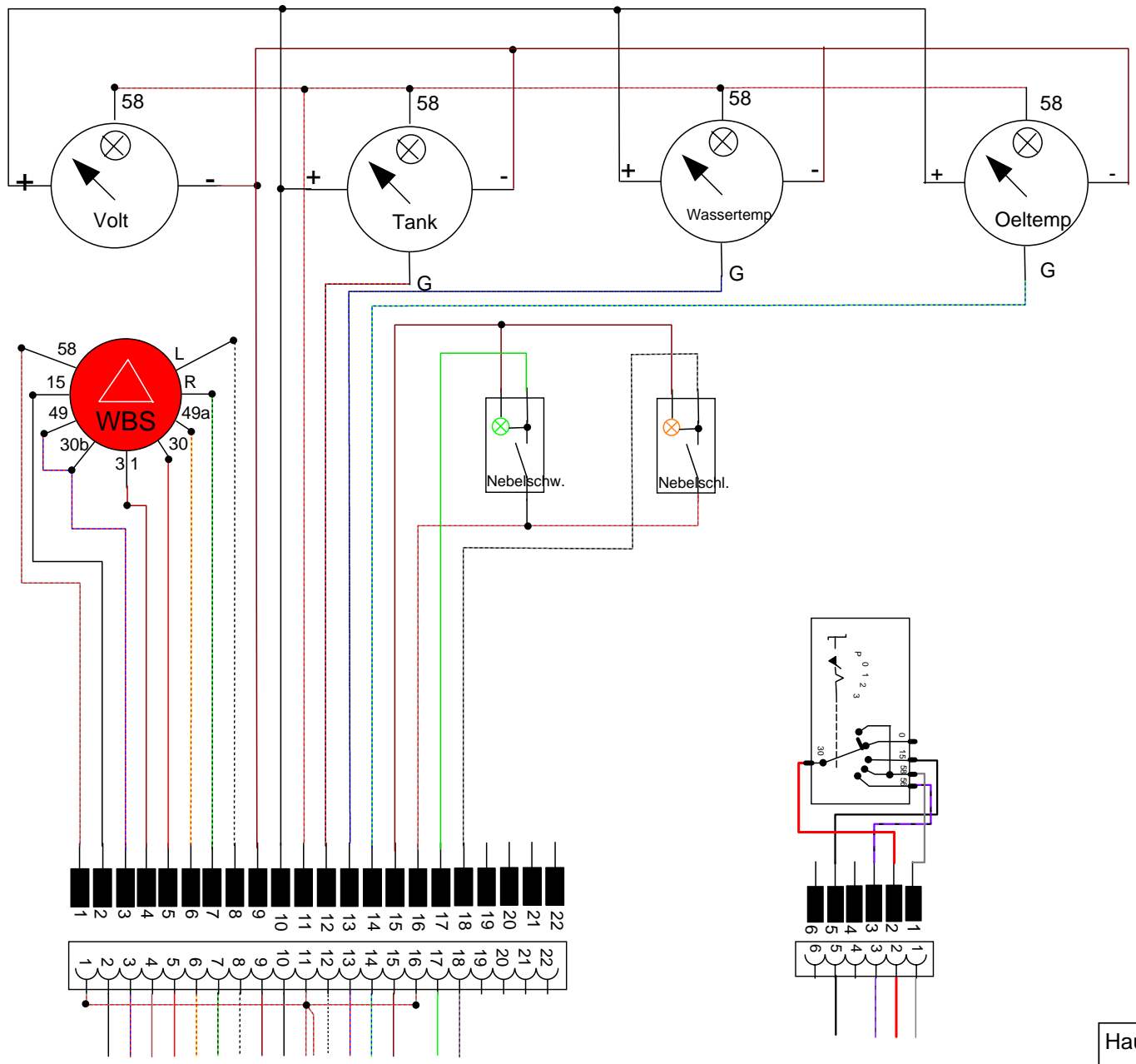

Hauptkabelbaum Rewaco RF1	ab Okt. 05
Datum 30.08.2005	

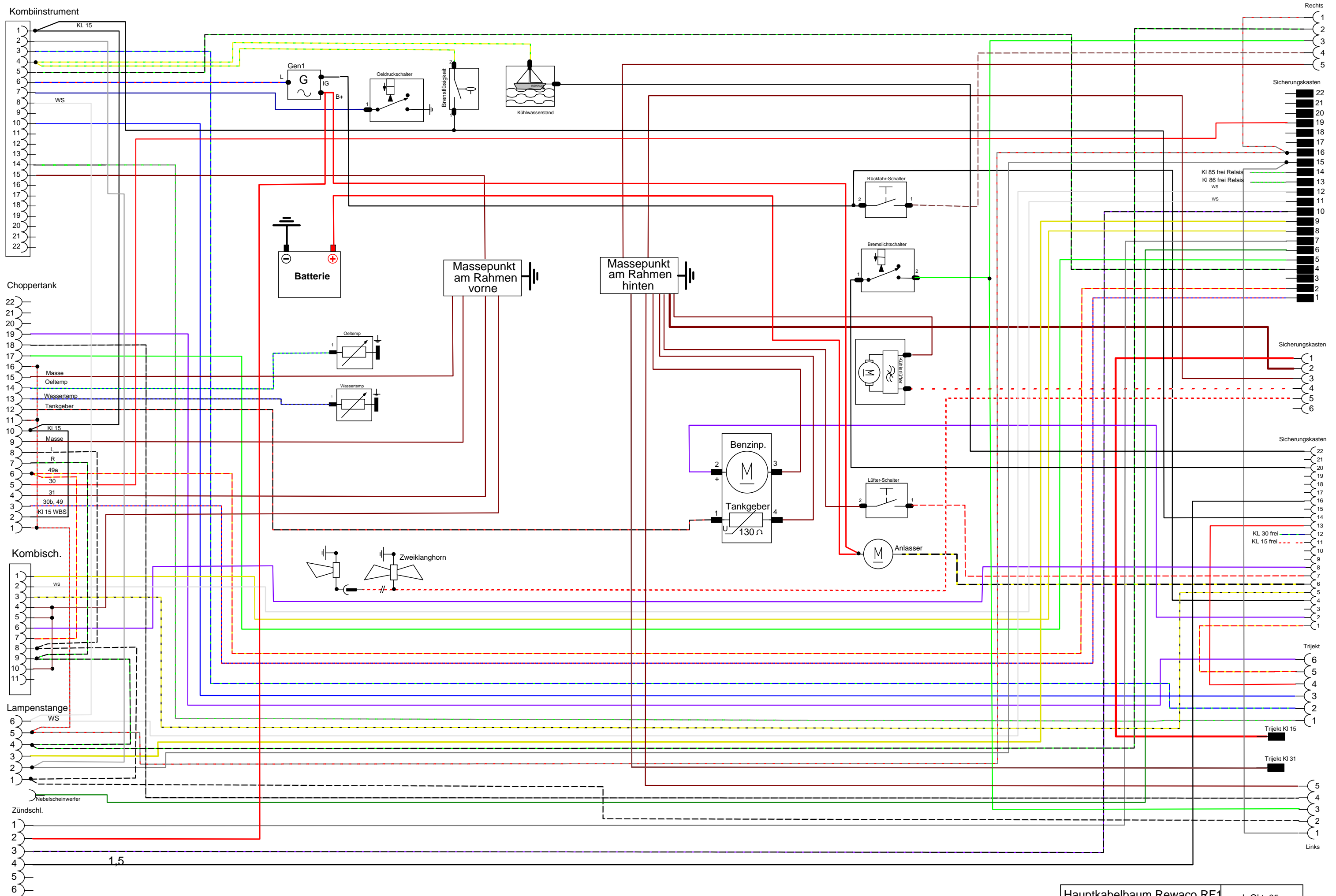

Kombiinstrument

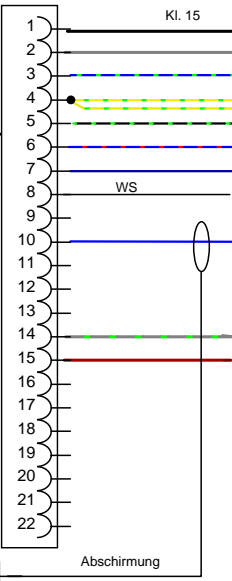

Choppertank

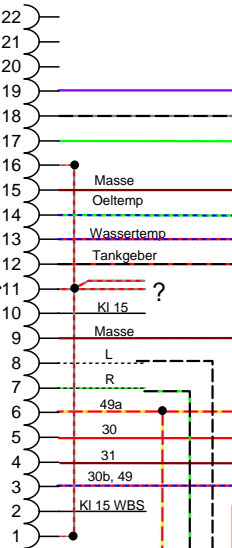

Kombisch.

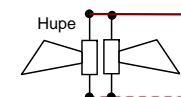
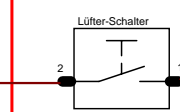
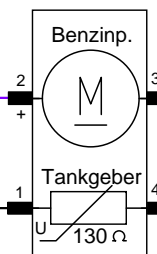
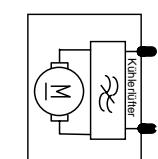
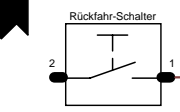
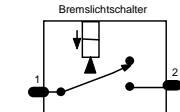
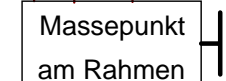
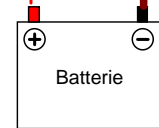
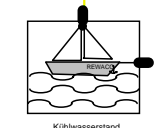
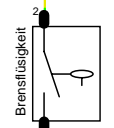
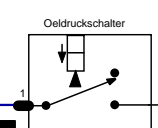
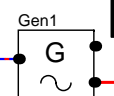
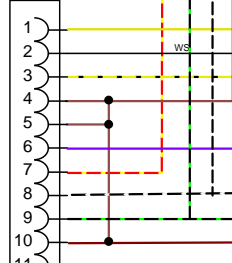

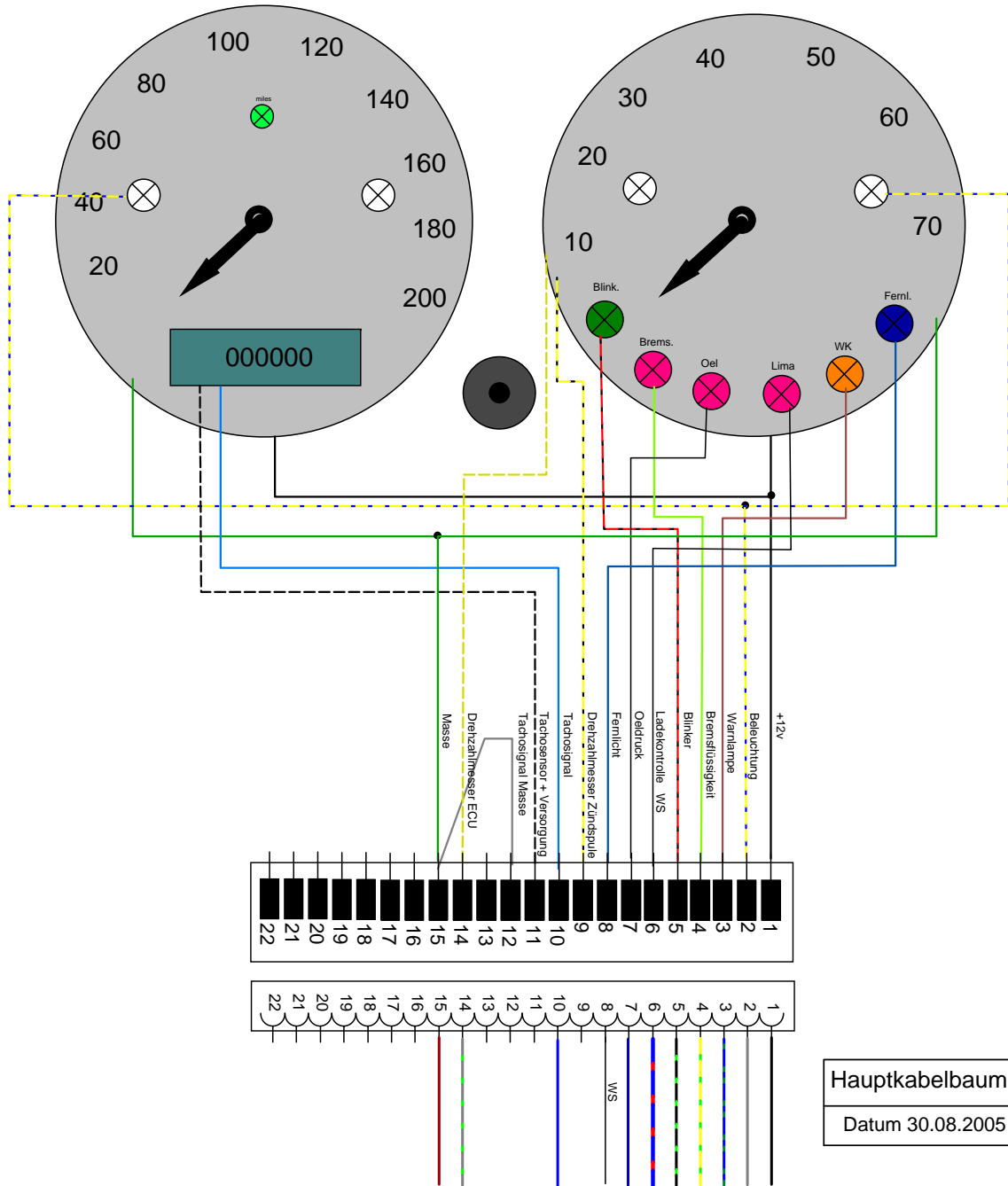

Hauptkabelbaum Rewaco RF1		ab Okt. 05
Datum 30.08.2005		

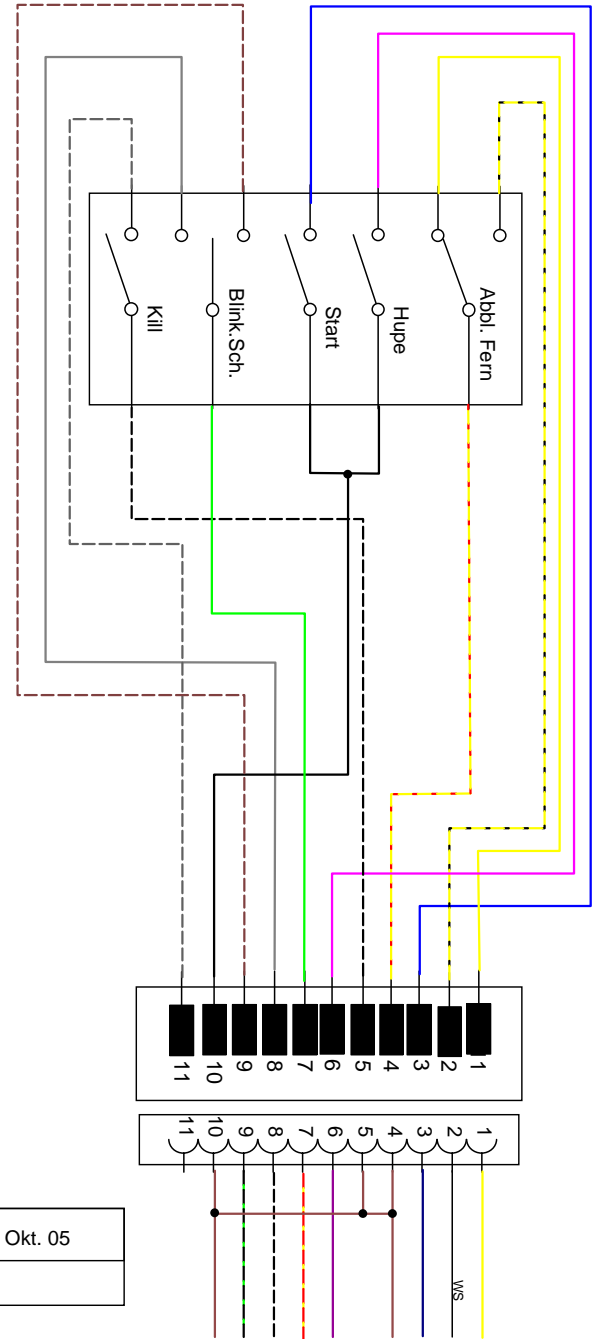

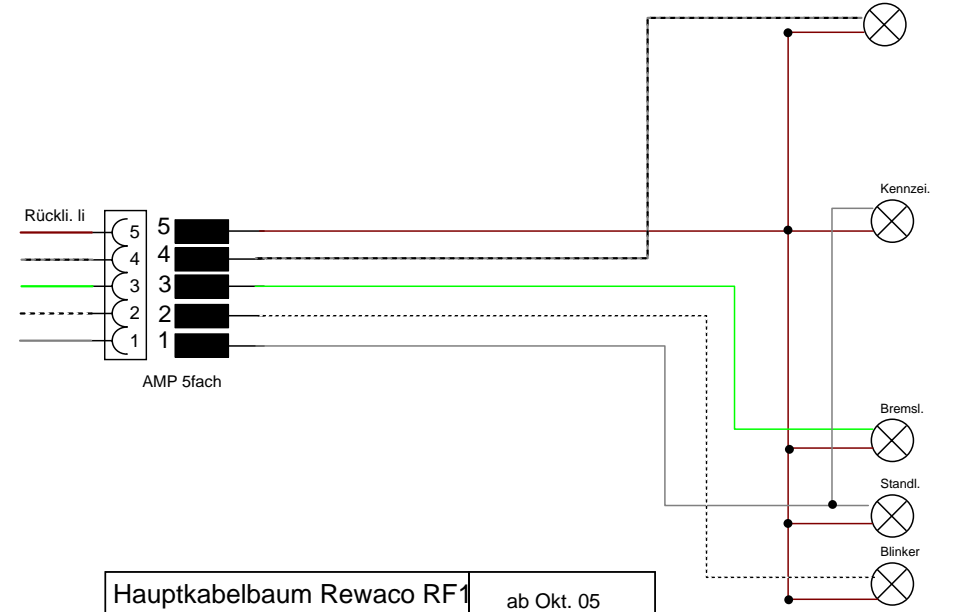
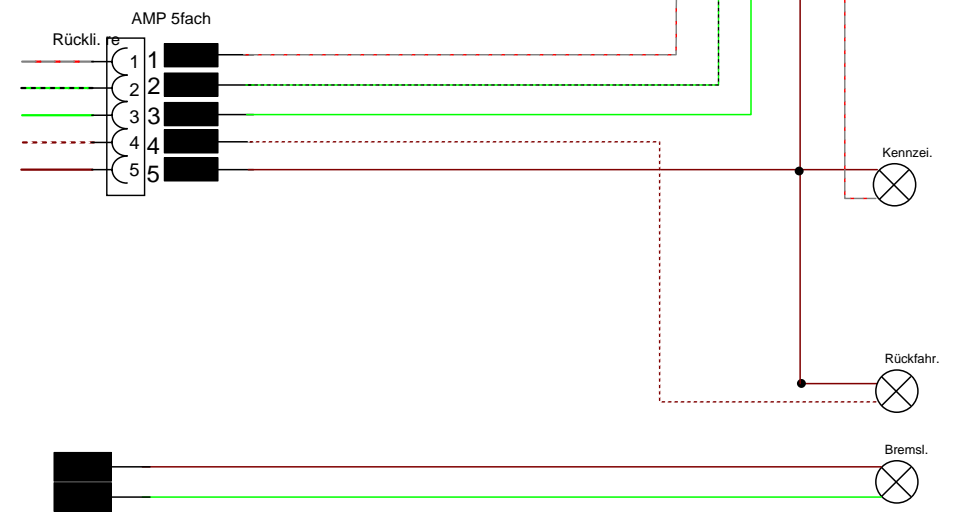
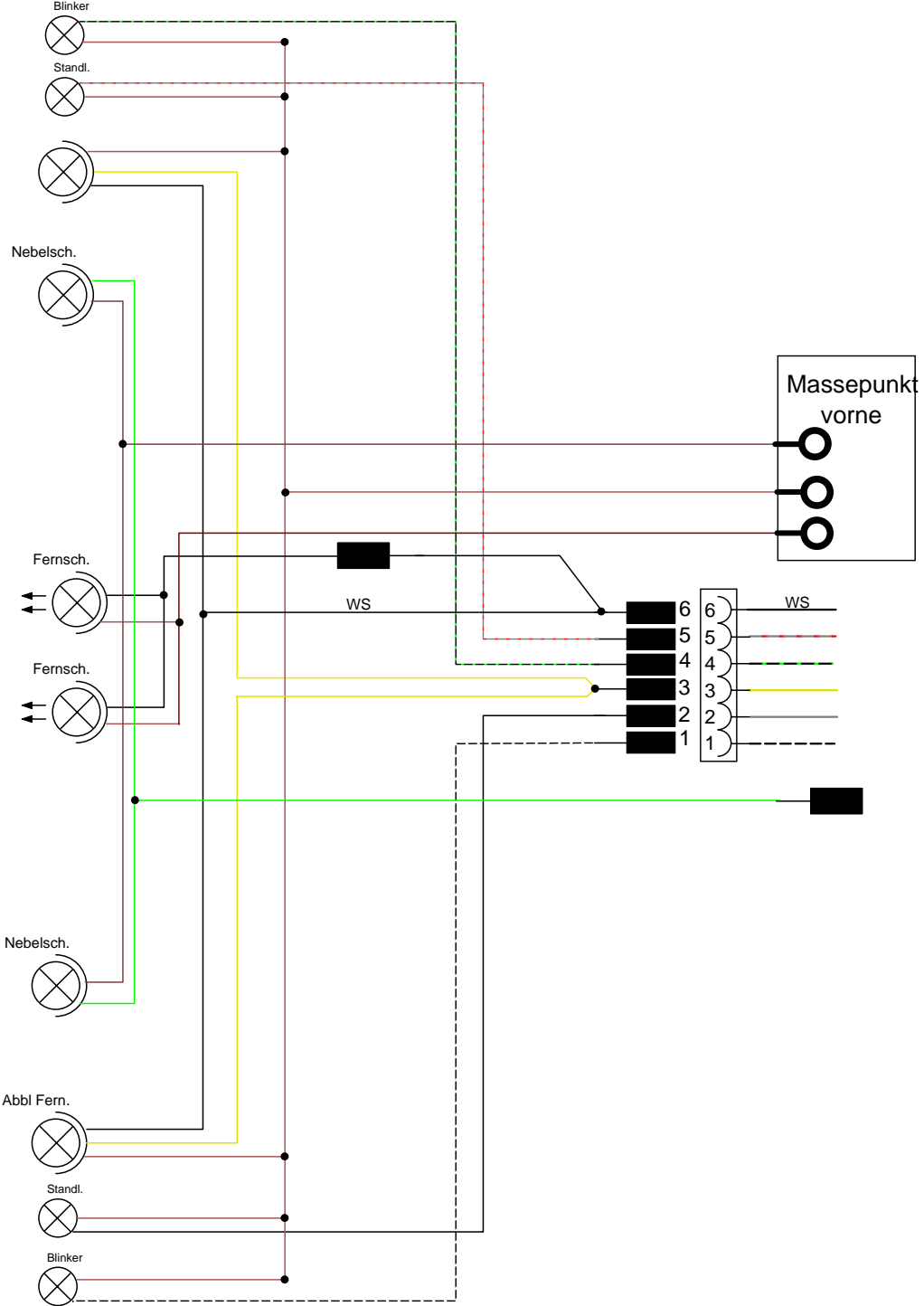

Hauptkabelbaum Rewaco RF1	ab Okt. 05
Datum 30.08.2005	

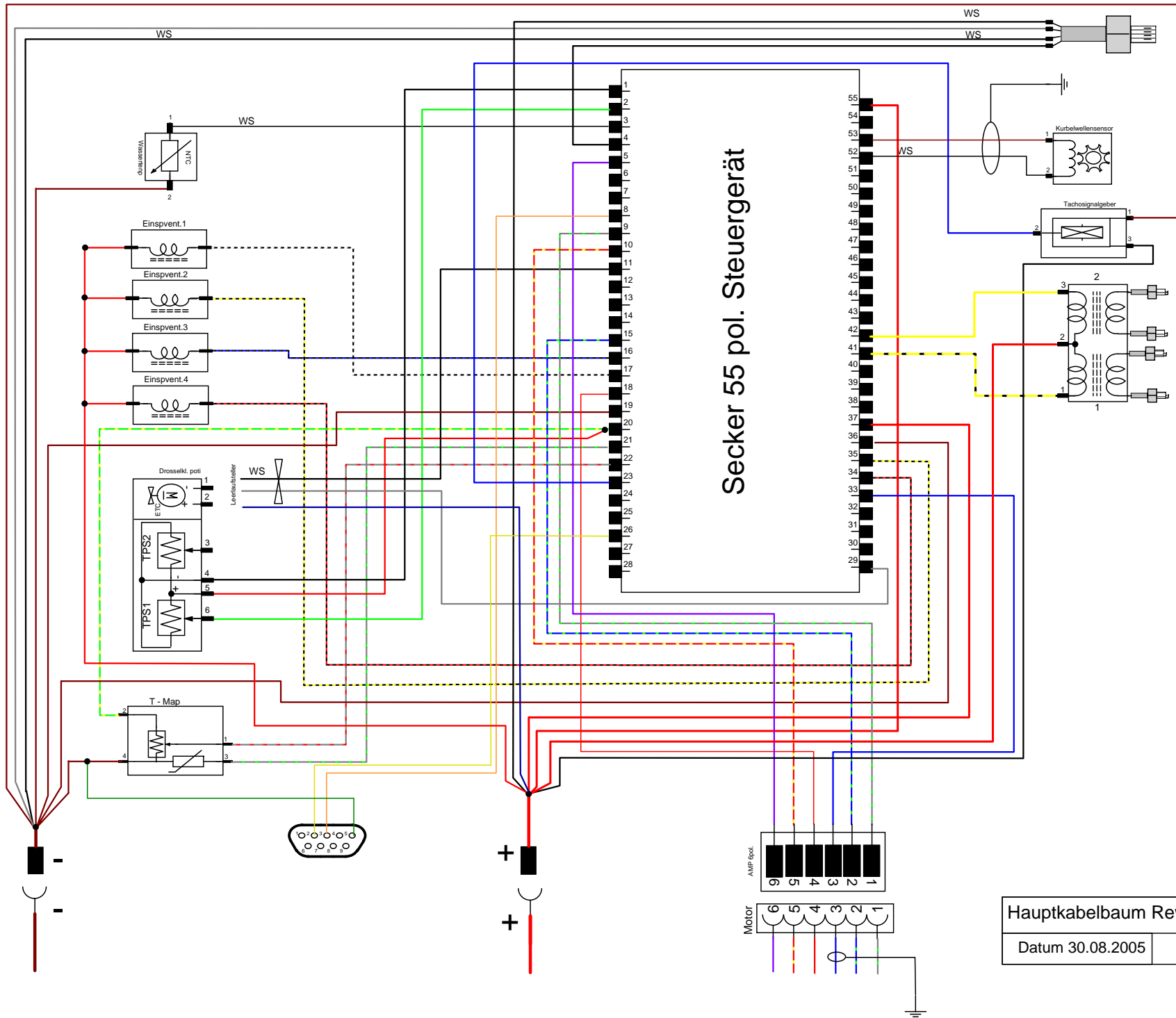

Secker 55 pol. Steuergerät

Hauptkabelbaum Rewaco RF1		ab Okt. 05
Datum 30.08.2005		

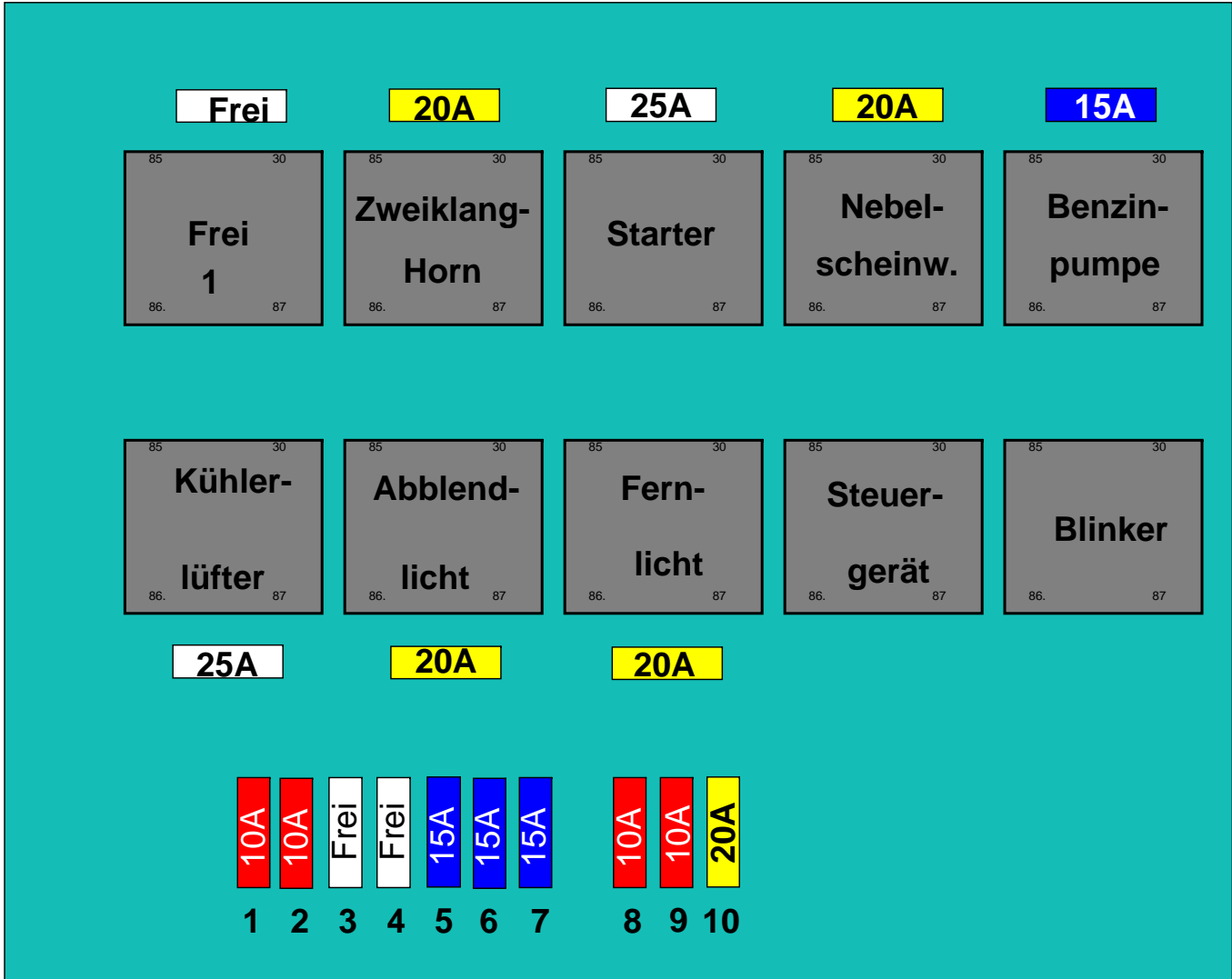

- 1) Kl.30 Motorsteuerung
- 2) Warnblinkschalter
- 3) Kl. 30 Frei
- 4) Kl. 15 Frei
- 5) Lichtmaschine, Rückfahrscheinwerfer
- 6) Kombiinstrument, Choppertank
- 7) Bremslicht
- 8) Standlicht rechts, Nebelschlußlicht
- 9) Standlicht links
- 10) Motorsteuerung